

# KSP44/45

## High Voltage Transistor

- Collector-Emitter Voltage:  $V_{CEO}$ =KSP44: 400V  
KSP45: 350V
- Collector Power Dissipation:  $P_C$  (max)=625mW

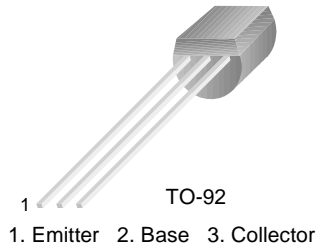

## NPN Epitaxial Silicon Transistor

### Absolute Maximum Ratings $T_a=25^\circ\text{C}$ unless otherwise noted

Symbol	Parameter	Value	Units
$V_{CBO}$	Collector-Base Voltage		
	: KSP44	500	V
	: KSP45	400	V
$V_{CEO}$	Collector-Emitter Voltage		
	: KSP44	400	V
	: KSP45	350	V
$V_{EBO}$	Emitter-Base Voltage	6	V
$I_C$	Collector Current	300	mA
$P_C$	Collector Power Dissipation ( $T_a=25^\circ\text{C}$ )	625	mW
$P_C$	Collector Power Dissipation ( $T_C=25^\circ\text{C}$ )	1.5	W
$T_J$	Junction Temperature	150	$^\circ\text{C}$
$T_{STG}$	Storage Temperature	-55 ~ 150	$^\circ\text{C}$

### Electrical Characteristics $T_a=25^\circ\text{C}$ unless otherwise noted

Symbol	Parameter	Test Condition	Min.	Max.	Units
$BV_{CBO}$	Collector-Base Breakdown Voltage	$I_C=100\mu\text{A}, I_B=0$			
	: KSP44		500		V
	: KSP45		400		V
$BV_{CEO}$	* Collector -Emitter Breakdown Voltage	$I_C=1\text{mA}, I_B=0$			
	: KSP44		400		V
	: KSP45		350		V
$BV_{EBO}$	Emitter-Base Breakdown Voltage	$I_E=100\mu\text{A}, I_C=0$	6		V
$I_{CBO}$	Collector Cut-off Current				
	: KSP44	$V_{CB}=400\text{V}, I_E=0$		0.1	$\mu\text{A}$
	: KSP45	$V_{CB}=320\text{V}, I_E=0$		0.1	$\mu\text{A}$
$I_{CES}$	Collector Cut-off Current				
	: KSP44	$V_{CE}=400\text{V}, I_B=0$		0.5	$\mu\text{A}$
	: KSP45	$V_{CE}=320\text{V}, I_B=0$		0.5	$\mu\text{A}$
$I_{EBO}$	Emitter Cut-off Current	$V_{EB}=4\text{V}, I_C=0$		0.1	$\mu\text{A}$
$h_{FE}$	* DC Current Gain	$V_{CE}=10\text{V}, I_C=1\text{mA}$	40		
		$V_{CE}=10\text{V}, I_C=10\text{mA}$	50	200	
		$V_{CE}=10\text{V}, I_C=50\text{mA}$	45		
		$V_{CE}=10\text{V}, I_C=100\text{mA}$	40		
$V_{CE}(\text{sat})$	* Collector-Emitter Saturation Voltage	$I_C=1\text{mA}, I_B=0.1\text{mA}$		0.4	V
		$I_C=10\text{mA}, I_B=1\text{mA}$		0.5	V
		$I_C=50\text{mA}, I_B=5\text{mA}$		0.75	V
$V_{BE}(\text{sat})$	* Base-Emitter Saturation Voltage	$I_C=10\text{mA}, I_B=1\text{mA}$		0.75	V
$C_{ob}$	Output Capacitance	$V_{CB}=20\text{V}, I_E=0, f=1\text{MHz}$		7	pF

\* Pulse Test:  $PW \leq 300\mu\text{s}$ , Duty Cycles  $\leq 2\%$

# Typical Characteristics

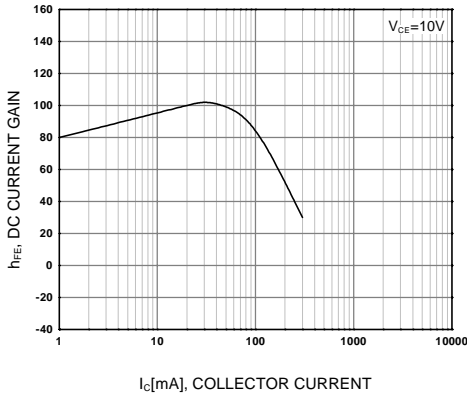

Figure 1. DC current Gain

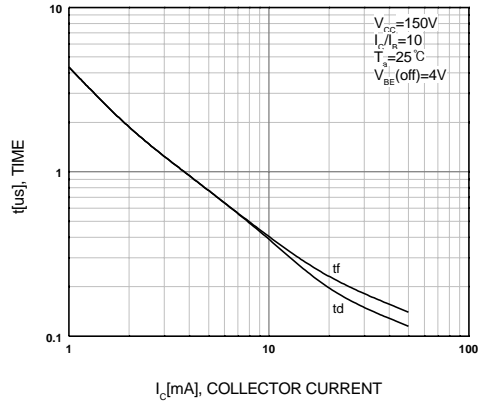

Figure 2. Turn-On Switching Times

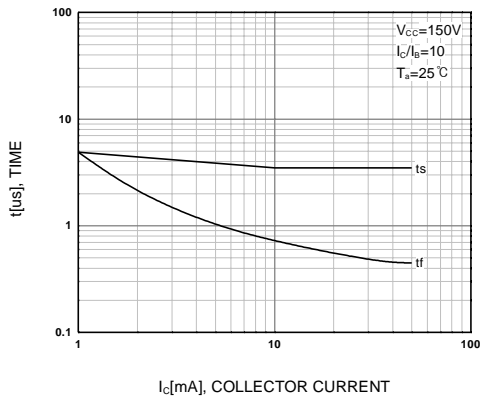

Figure 3. Turn-Off Switching Times

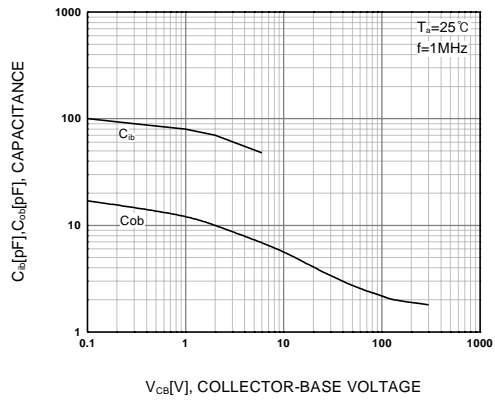

Figure 4. Capacitance

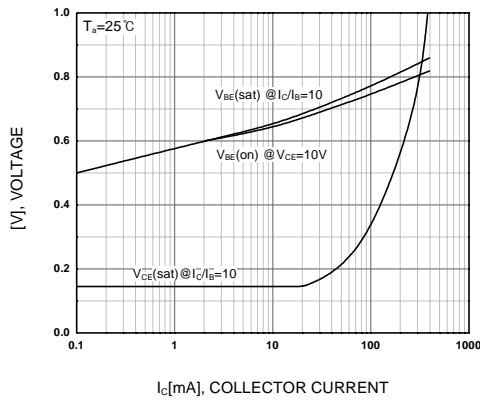

Figure 5. On Voltage

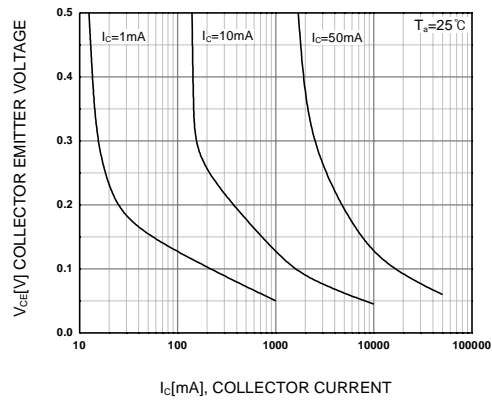

Figure 6. Collector Saturation Region

Typical Characteristics (Continued)

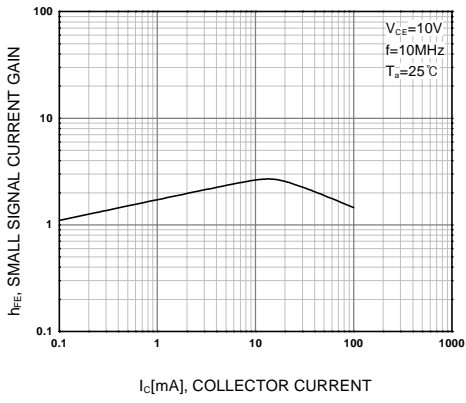

Figure 7. High Frequency Current Gain

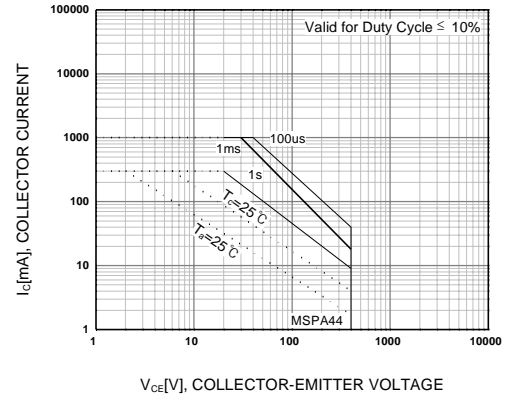
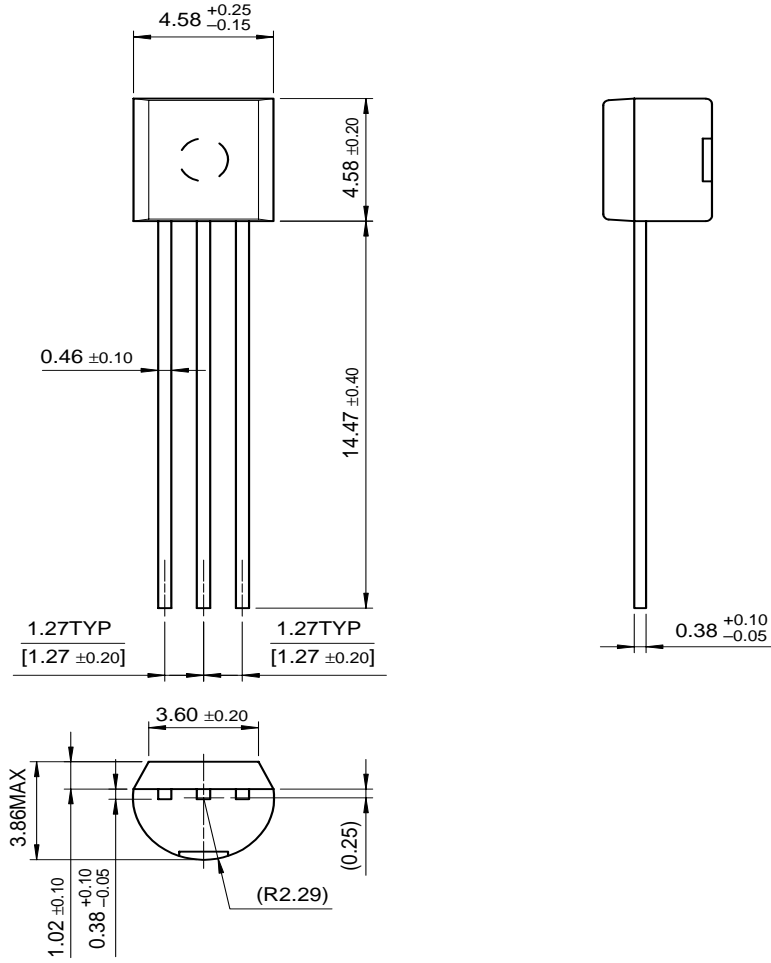

Figure 8. Safe Operating Area

# Package Dimensions

## TO-92



Dimensions in Millimeters

## TRADEMARKS

The following are registered and unregistered trademarks Fairchild Semiconductor owns or is authorized to use and is not intended to be an exhaustive list of all such trademarks.

ACE <sup>™</sup>	FACT <sup>™</sup>	ImpliedDisconnect <sup>™</sup>	PACMAN <sup>™</sup>	SPM <sup>™</sup>
ActiveArray <sup>™</sup>	FACT Quiet series <sup>™</sup>	ISOPLANAR <sup>™</sup>	POP <sup>™</sup>	Stealth <sup>™</sup>
Bottomless <sup>™</sup>	FAST <sup>®</sup>	LittleFET <sup>™</sup>	Power247 <sup>™</sup>	SuperSOT <sup>™</sup> -3
CoolFET <sup>™</sup>	FAST <sup>r</sup> <sup>™</sup>	MicroFET <sup>™</sup>	PowerTrench <sup>®</sup>	SuperSOT <sup>™</sup> -6
CROSSVOLT <sup>™</sup>	FRFET <sup>™</sup>	MicroPak <sup>™</sup>	QFET <sup>™</sup>	SuperSOT <sup>™</sup> -8
DOME <sup>™</sup>	GlobalOptoisolator <sup>™</sup>	MICROWIRE <sup>™</sup>	QS <sup>™</sup>	SyncFET <sup>™</sup>
EcoSPARK <sup>™</sup>	GTO <sup>™</sup>	MSX <sup>™</sup>	QT Optoelectronics <sup>™</sup>	TinyLogic <sup>™</sup>
E <sup>2</sup> CMOS <sup>™</sup>	HiSeC <sup>™</sup>	MSXPro <sup>™</sup>	Quiet Series <sup>™</sup>	TruTranslation <sup>™</sup>
EnSigna <sup>™</sup>	I <sup>2</sup> C <sup>™</sup>	OCX <sup>™</sup>	RapidConfigure <sup>™</sup>	UHC <sup>™</sup>
Across the board. Around the world. <sup>™</sup>		OCXPro <sup>™</sup>	RapidConnect <sup>™</sup>	UltraFET <sup>®</sup>
The Power Franchise <sup>™</sup>		OPTOLOGIC <sup>®</sup>	SILENT SWITCHER <sup>®</sup>	VCX <sup>™</sup>
Programmable Active Droop <sup>™</sup>		OPTOPLANAR <sup>™</sup>	SMART START <sup>™</sup>	

## DISCLAIMER

FAIRCHILD SEMICONDUCTOR RESERVES THE RIGHT TO MAKE CHANGES WITHOUT FURTHER NOTICE TO ANY PRODUCTS HEREIN TO IMPROVE RELIABILITY, FUNCTION OR DESIGN. FAIRCHILD DOES NOT ASSUME ANY LIABILITY ARISING OUT OF THE APPLICATION OR USE OF ANY PRODUCT OR CIRCUIT DESCRIBED HEREIN; NEITHER DOES IT CONVEY ANY LICENSE UNDER ITS PATENT RIGHTS, NOR THE RIGHTS OF OTHERS.

## LIFE SUPPORT POLICY

FAIRCHILD'S PRODUCTS ARE NOT AUTHORIZED FOR USE AS CRITICAL COMPONENTS IN LIFE SUPPORT DEVICES OR SYSTEMS WITHOUT THE EXPRESS WRITTEN APPROVAL OF FAIRCHILD SEMICONDUCTOR CORPORATION.

As used herein:

1. Life support devices or systems are devices or systems which, (a) are intended for surgical implant into the body, or (b) support or sustain life, or (c) whose failure to perform when properly used in accordance with instructions for use provided in the labeling, can be reasonably expected to result in significant injury to the user.
2. A critical component is any component of a life support device or system whose failure to perform can be reasonably expected to cause the failure of the life support device or system, or to affect its safety or effectiveness.

## PRODUCT STATUS DEFINITIONS

### Definition of Terms

Datasheet Identification	Product Status	Definition
Advance Information	Formative or In Design	This datasheet contains the design specifications for product development. Specifications may change in any manner without notice.
Preliminary	First Production	This datasheet contains preliminary data, and supplementary data will be published at a later date. Fairchild Semiconductor reserves the right to make changes at any time without notice in order to improve design.
No Identification Needed	Full Production	This datasheet contains final specifications. Fairchild Semiconductor reserves the right to make changes at any time without notice in order to improve design.
Obsolete	Not In Production	This datasheet contains specifications on a product that has been discontinued by Fairchild semiconductor. The datasheet is printed for reference information only.